

# Instruction Manual

## Ion Pump Control Unit IPC-0062



Copyright © 1998 by Duniway Stockroom Corp.

# Table of Contents

---

**I Technical Specification** **page 5**

- A. Electrical
- B. Physical Specifications

**II Pre-Installation Information** **page 8**

- A. General Considerations
- B. Compatibility
- C. System Design Considerations
- D. Physical Requirements
- E. Electrical Requirements

**III Installation and Setup** **page 11**

- A. Power Requirements
- B. High Voltage Changeover Procedure
- C. Output Voltage Polarity Changeover Procedure
- D. Safety Requirements
- E. Connection to Pump
- F. Use with a Pressure Relay
- G. Use with a Recorder

**IV Operation** **page 20**

- A. Pre-Start Checks
- B. Start-Mode Operation
- C. Normal-Mode Operation

**V Parts List & Schematic** **page 26**

- A. List
- B. Schematic

## List of Illustrations

---

Figure 1 Power Curve : +/- 5200 Volt Settings	page 5
Figure 2 Power Curve : +/- 3200 Volt Settings	page 5
Figure 3 Line Voltage Tap & Jumper Positions Diagram	page 12
Figure 4 Rear Panel Photograph	page 14
Figure 5 Top View - Cover Removed for Service	page 14
Figure 6 Recorder Output versus Pressure Plot Chart	page 19
Figure 7 Front Panel Photograph	page 21
Figure 8 Pump Current vs. Pressure, Selected Ion Pumps	page 24

## Important Notices

***NOTES, CAUTIONS AND WARNINGS!*** contained in the text provide important information. Please give them your attention to protect yourself, others and your equipment.

### ***NOTE***

A ***NOTE*** provides additional or special information to assist operation and/or maintenance personnel. Disregarding a note may cause inconvenience but will *generally* not result in personal injury or equipment damage.

### **CAUTION**

A **CAUTION** is provided in a procedure whenever mechanical or electrical damage may occur. Failure to heed a caution will result in some form of damage to the equipment; however, personal injury is unlikely.

### **WARNING!**

A **WARNING!** is provided in a procedure where personal injury may occur if the **WARNING!** is not heeded. Mechanical or electrical damage *may also occur*.

Again, observe all ***NOTES, CAUTIONS AND WARNINGS!*** contained in the text.

## I Technical Specification

Electrical output, Voltage vs Current and Power vs. Current, are shown in Figure 1 for the 5200 volt setting and in Figure 2 for the 3200 volt setting. The “power hill” shown in these figures must be “climbed” by the pump in going through the START sequence by progressing from high pressure (current) to low pressure (current). The shape of this curve is determined by the characteristics of the main power transformer (T1). This component has been engineered to optimize the START mode for the approved sputter-ion pumps.

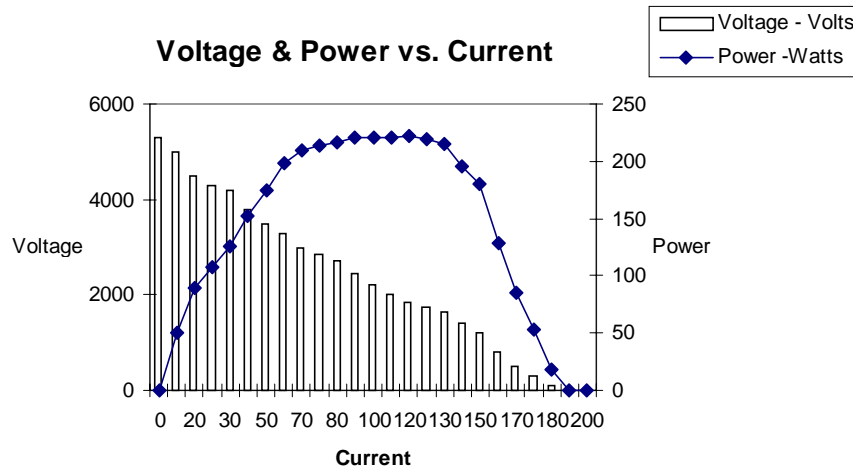

**Figure 1 Power Curve : +/- 5200 Volt Settings**

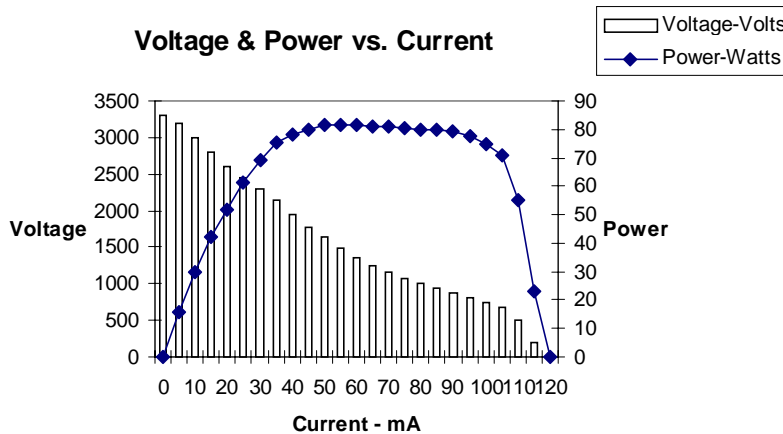

**Figure 2 Power Curve : +/- 3200 Volt Settings**

## A. Electrical

### INPUT PARAMETERS

Voltage	115/230 VAC, single phase, 50/60 Hz, with internal taps for voltage change.
Current	10 Amps maximum in START mode (115VAC). 5 Amps maximum in START mode (230VAC)

### OUTPUT PARAMETERS

Open Circuit Voltage	+/-5200 +/- 10% VDC or +/-3300 +/- 10% VDC Internal taps for voltage change, and polarity select on the rear panel.
Short Circuit Current	for 60 Hz operation: +/-200 mA +/- 10% or +/-120 mA +/- 10%  for 50 Hz operation: +/-167 mA +/- 10% or +/-100 mA +/- 10%
Overload Protection	Fuse for line power. Power automatically turned off if pressure is greater than about 0.5 mTorr <b>AND</b> the START/PROTECT switch is in the protect position.
Shutoff Currents	+/-65 mA +/- 20% in the 8, 20 or 30 liter per second positions, or: +/- 108 mA +/- 20% in the 60 liter per second position
Metering	20 microAmp +/- 2% taut band meter
Current Scales	200 mA to 20 microA, +/- 10% in 5 scale positions
Pressure Scale	Modified log scale, $10^{-4}$ to $10^{-8}$ Torr, matched to switch-selected pump.
Voltage Scale	0 - 6KV

### RECORDER OUPUT

Voltage	+/- 0-100mV from the Pressure Scale
---------	-------------------------------------

## B. Physical Specifications

### CABLES

Line Power	6.7 foot (2 meter) length Belden Type 17250 or equivalent NEMA 5-15P grounding plug PH-290B
High Voltage Output	Non-Bakeable (Standard): 10 foot (3.1 meter) length Polyethylene coaxial cable  Bakeable (Optional) 12 foot (3.7 meter) length Teflon coaxial cable Stainless steel wrap

### DIMENSIONS

Panel	7 in (17.8 cm) H x 8.3 in (21.1 cm) W
Cabinet Depth	15.1 in (38.4 cm) deep (Allow 4 in (10.2 cm) extra for cable clearance)

### WEIGHT

Installed Weight	34 lb (15kg)
Shipping Weight	40 lb (18kg)

### ENVIRONMENTAL LIMITATIONS

Temperature	32°F to 105°F(0°C to 40°C)
Humidity	Non- condensing atmosphere
Altitude	10,000 feet (3100 meters)

---

## II Pre-Installation Information

### A. General Considerations

The IPC-0062 Ion Pump Control unit is designed to operate either diode or triode sputter ion pumps in both the NORMAL and START modes. These generic pump types differ in two important ways; namely:

**Diode pumps require positive high voltage. Typical examples for the IPC-0062 would be the 8 l/s, 20 l/s, 30 l/s and 60 l/s models.**

**Triode pumps require negative high voltage. Typical examples for the IPC-0062 would be the 20 l/s, 30 l/s, 45 l/s and 60 l/s models.**

In addition, in the START mode,

Diode pump electrical discharges are not confined within the pump elements.

Triode pump electrical discharges are well confined within the pump elements.

A typical sputter ion pump is generally very tolerant of a wide range of power supply operating characteristics in the NORMAL mode of operation. This mode exists at pressures less than the critical transition pressure, usually around  $10^{-4}$  torr. This pressure depends upon the design of the pump in relation to such parameters as anode cell geometry and magnetic field. For more information on this topic, please contact your Duniway Stockroom Corporation customer support representative.

In the START mode of operation, sputter ion pumps are generally very intolerant of improper matching of the pump requirements to the electrical characteristics of the power supply.

### CAUTION

**Operate ONLY approved sputter-ion pumps with the IPC-0062.**

### EXPLANATION OF CAUTION:

In general, if the power supply capacity is inadequate for the sputter ion pump in use, then sufficient net pumping speed may not be developed at high pressure due to excessive current demands. The result is that it may be difficult to reduce the pressure below the transition pressure. In such a case, the pressure will not decrease significantly, but the pump will not overheat or be damaged. If the pump is successfully started with a power supply of inadequate capacity, it is likely to exhibit anomalous behavior in the NORMAL mode, such as a tendency to “plateau” at various pressures during the pumpdown cycle. This occurs because sufficient heat was not generated



during the START mode operation to outgas the pump body and elements. Finally, if a power supply with capacity substantially in excess of that recommended for the pump is used, starting may be impossible due to excessive heating and outgassing from the high temperatures generated in the pump. In cases of protracted operation in the START mode with significant excess control unit current capacity, it is possible for the pump elements to be irreversibly damaged.

For operation of any other pump not listed above, please consult Duniway Stockroom Corporation.

## B. Compatibility

The IPC-0062 Control Unit is designed to be highly compatible and interchangeable with the Varian Model 921-0062 VacIon Ion Pump Control Unit. Duniway Stockroom Corporation has incorporated several modifications to enhance reliability. These include:

<u>FEATURE</u>	<u>BENEFIT</u>
Reinforced Frame	Avoids sagging of frame due to the weight of the power transformer when the sides are removed.
4-screw removal of front and rear panels.	Avoids the necessity of removing electrical hardware for service of internal components.
Demountable line cord	Simplifies removal of the unit for service.
High Voltage ON lamp on rear panel.	Added safety in servicing rack mounted installations.

Many major electrical and electronic components are directly interchangeable between the IPC-0062 and the Varian 921-0062. Consult this manual and corresponding sections of the Varian manual for further information.

## C. System Design Considerations

Many system design considerations are important to the operation of a sputter ion pump, such as matching of control unit and pump, size of chamber, materials used in the system, gas loads encountered in operation, cleanliness of materials and many others. This is particularly important in the START mode. A detailed discussion of these effects is beyond the scope of this manual, but design assistance and/or consultation is available. For more information, please contact Duniway Stockroom Corporation.

## **D. Physical Requirements**

The IPC-0062 controller can be installed and operated using the optional rack mounting kit or as a “stand-alone” unit, provided all safety requirements are met. (See SECTION III D, SAFETY REQUIREMENTS for details.)

When controlling a sputter-ion pump in the NORMAL mode, the power dissipated as heat by the IPC-0062 is negligible. However, during the START mode, a modest heat load is presented. This heat load is generally on the order of 50 watts or less.

Dimensions and rack mounting information can be found in SECTION I, SPECIFICATIONS of this manual.

## **E. Electrical Requirements**

The IPC-0062 controller is designed to be operated from either 115 VAC, 50/60 Hz or 230 VAC, 50/60 Hz, selectable via internal taps on the power transformer. This procedure is described in SECTION III A, POWER REQUIREMENTS, and detailed electrical requirements may be found in SECTION I, SPECIFICATIONS.

### III Installation and Setup

#### A. Power Requirements

The IPC-0062 is designed to operate from the power input as shown in SECTION I, SPECIFICATIONS. AC line power is supplied to the unit through a demountable power cord (Belden P/N 17250 or equivalent for 115 VAC operation), to a recessed power receptacle (Belden P/N 17253) rated for 10 Amps, 250 VAC and approved for use in the USA, Canada and European countries.

Unless otherwise specified, the IPC-0062 is shipped configured for 115 VAC operation. However, as with all dual voltage electrical apparatus, it is prudent to confirm the voltage selection prior to application of power to the unit.

**WARNING!**  
**Both line voltage and the voltages developed in this unit are dangerous and exposure could be lethal.**

***PROCEDURE:***                      **LINE VOLTAGE CHANGE**

Reference: Figure 3, below and SECTION V - SCHEMATIC

1. Disconnect the power cord from the rear of the IPC-0062 (J1).
2. Disconnect the High Voltage cable from the rear of the IPC-0062 (J4).
3. Connect a shorting wire from the shell to the center conductor of the High Voltage connector (J4). This is to assure discharge of any remaining high voltage. Remove the perforated metal cover. This involves the removal of 4 screws, be sure to save the screws in a place where they can be easily retrieved.
4. Change the taps and shorting bars on the main power transformer primary winding to correspond to the configuration for the desired line voltage. Refer to Figure 3 on page 12, and the SECTION V - SCHEMATIC. Make sure that the terminal screws are tight.
5. Select the desired line voltage on slide switch, S2 on the printed circuit board.
6. Change the fuse, F1, if required. 115VAC operation requires a 10 amp slo-blo fuse, while 230VAC operation requires a 5 amp slo-blo fuse.
7. Replace the perforated metal cover.
8. Remove the shorting wire from the High Voltage connector. (J4)

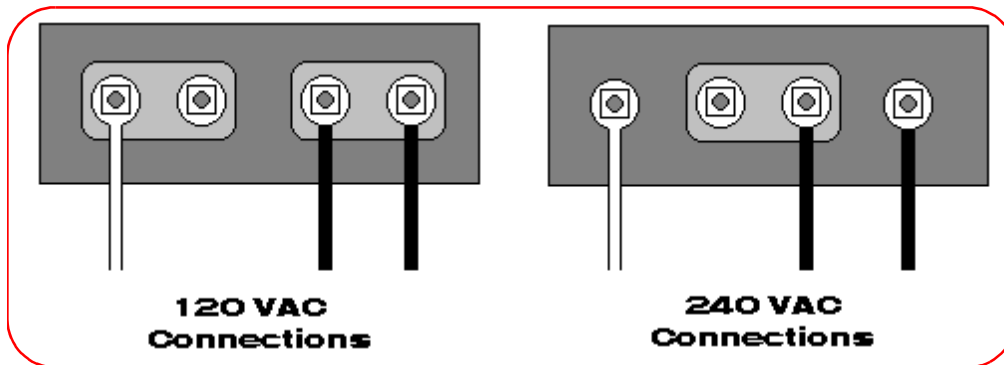

**Figure 3 Line Voltage Tap & Jumper Positions Diagram**

(Note: Taps are located on the Power Transformer - T1)

(See also Figure 5 and Schematic Diagram)

## B. High Voltage Changeover Procedure

High Voltage may be changed by selecting the appropriate tap on the secondary winding of the main power transformer T1.

### **WARNING!**

**Both line voltage and the voltages developed in this unit are dangerous and exposure could be lethal.**

### ***PROCEDURE:* HIGH VOLTAGE CHANGEOVER PROCEDURE**

#### **Reference: Schematic Drawing Section V and Figure 4 - Rear Panel Photograph**

1. Disconnect the power cord (J1) from the rear of the IPC-0062.
2. Disconnect the High Voltage line (J4) from the rear of the IPC-0062.
3. Connect a shorting wire from the shell to the center conductor of the High Voltage connector (J4).
4. Remove the perforated metal cover of the IPC-0062 by removing the four screws. Be careful not to drop the screws inside the unit.
5. Connect the high voltage lead (secondary of transformer T1) to either terminal 6 or terminal 7, as required.

Terminal 6 is used for 3300 Volts DC output.  
Terminal 7 is used for 5200 Volts DC output.

Make sure that the terminal screws are tight.

6. Replace the perforated metal cover.
7. Remove the shorting wire from the High Voltage connector (J4).
8. Check the Output Polarity switch (S3) on the rear panel to confirm the setting to the desired polarity.

### C. Output Voltage Polarity Changeover Procedure

#### **CAUTION**

**Never change the Output Polarity selection switch S3 while the unit is operating. Severe damage may result!**

The output polarity can be changed by means of switch S3 on the rear panel of the IPC-0062. (See Figure 4 - Rear Panel Photograph).

In general, sputter ion pumps of the diode or noble diode or DI variety require a positive high voltage, while pumps of the triode or StarCell variety require negative high voltage. If you have any question about the matching of your specific pump with the IPC-0062, call Duniway Stockroom Corporation and ask for assistance in identifying the correct settings.



**Figure 4 Rear Panel Photograph**

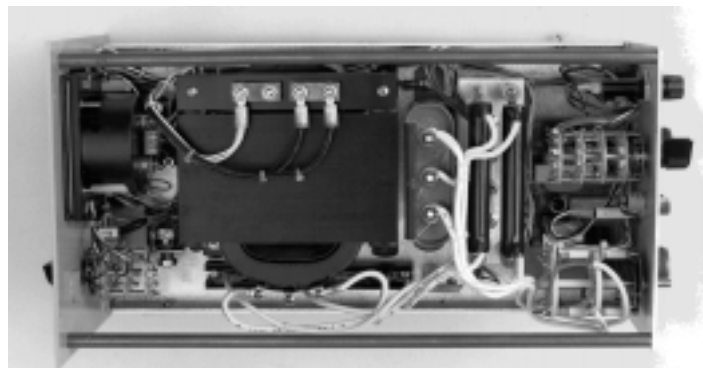

**Figure 5 Top View - Cover Removed for Service**

## D. Safety Requirements

The primary safety hazard when operating high voltage power supplies such as the IPC-0062 is electrical shock. Electrical shock can result from contact with the AC line voltage, internal potentials in the control unit or the high voltage output of the unit itself. The high voltage output hazard can exist either from direct contact with the high voltage lead or as a result of loss of proper grounding of the unit or the pump.

In addition, a large filter capacitor, C1, (2x0.3microfarad, 5KV) is employed in the IPC-0062. Although a 10Megohm, 5W “bleeder resistor” (R2) is employed to dissipate the charge on these capacitors when the IPC-0062 is turned off, failure of the resistor could allow a stored energy of more than 2 Joules to remain in the capacitors.

### **WARNING!**

**Always wait at least 15 seconds after turning OFF high voltage before working on either the IPC-0062 or the sputter-ion pump.**

### **NOTE**

**In a properly operating IPC-0062, the absence of hazardous potentials on the high voltage output may be verified by reading the high voltage meter on the front panel.**

A Safety Interlock circuit has been incorporated into the IPC-0062 to reduce the risk of electrical shock in the case that proper grounding is lost. While grounding is generally provided through the high voltage cable, it is recommended that a separate grounding strap be attached from the pump to the control unit.

### **CAUTION**

**The ground safety strap connector (the binding post on the rear panel) is for *ground fault sensing* only, and may NOT be used for the ground connection itself.**

**PROCEDURE: GROUND FAULT SAFETY STRAP**

1. Ensure that continuity exists between the high voltage output connector shell (J4) and the sputter-ion pump body. While the outer shielding braid of the high voltage cable is commonly used for this function, by making connection through the grounding spring on the high voltage feedthrough of the sputter-ion pump, this is a marginal technique and separate grounding is recommended.

A separate braid, Belden 8669 or equivalent, fastened between a mounting screw of the shell on the high voltage connector (J4) and any convenient fastener on the ion pump body is recommended.

2. Make a connection between the ground safety strap on the rear panel of the IPC-0062 (See Figure 4 - Photograph of Rear Panel) and any convenient fastener on the sputter ion pump body.
3. If there is a ground fault (open circuit), the Ground Fault Sensing Circuit will remove power from the main power transformer of the IPC-0062 and the white FAULT lamp on the front panel will be illuminated. To restore power, correct the grounding problem and press the RESET button on the front panel.

**WARNING!**

**Under no circumstances should the ground safety strap be connected directly to the case of the IPC-0062. That would defeat the protection provided by this safety feature and may result in serious electrical shock hazard to personnel.**

***NOTE***

The same circuit will also remove power from the main power transformer and cause the FAULT lamp to be illuminated if an overload condition occurs during normal operation. (See SECTION III, NORMAL OPERATION)

**E. Connection to Pump**

The IPC-0062 is connected to a sputter-ion pump by means of a coaxial cable assembly. If desired, special longer or shorter cables can be used with no loss of pump performance. Call Dun-  
iway Stockroom Corporation for information about longer, custom length cables.



**PROCEDURE: CONNECTION TO THE PUMP**

1. Turn OFF the POWER switch on the front panel of the IPC-0062. (See Figure 7 - Front Panel Photograph)
2. Remove the LINE POWER CORD (J1) from the rear panel of the IPC-0062.
3. Make or confirm the required ground connections as described above in Section D.
4. Position the GROUNDING SPRING on the pump high voltage feedthrough in the recess between the ceramic body of the high voltage insulator and the weld sleeve. If the pump has another type of high voltage feedthrough, contact Duniway Stockroom Corporation to obtain the proper high voltage cable termination.
5. Push the cable connector (pump end of the cable) over the high voltage connector, twisting the connector as needed until the connector body slides over the grounding spring and will go no further.
6. Align the hole in the cable connector with the pump bracket and install the safety screw supplied with the pump.
7. Connect the M/S connector (P4) (control unit end of high voltage cable) to the high voltage output connector (J4) on the rear of the control unit.
8. Connect the Line Power cord to J1 on the rear of the control unit.

**WARNING!**

**NEVER apply power to the IPC-0062 until proper grounding has been checked and verified.**

**NEVER operate the IPC-0062 without the safety screw installed.**

## F. Use with a Pressure Relay

A multi pin connector (J2) is provided on the rear panel to connect the IPC-0062 to a pressure relay, such as the Varian 924-0048 or the Duniway Stockroom Corporation PR-0048. This accessory is used for controlling the heaters in a bakeout unit for the pump and system.

For use of the Pressure Relay, consult the instruction manual supplied with the unit. The IPC0-0062 is fully compatible with the 924-0048 and PR-0048.

## G. Use with a Recorder

A recorder output connector, J3, is provided on the front panel of the IPC-0062. The recorder output is +/-100 mV related to the logarithmic "PRESSURE" indicator. Full scale deflection on the "PRESSURE" scale of the front meter corresponds to 100 mV output on the recorder output connector.

### CAUTION

**DO NOT use a chart recorder or other measuring device on the IPC-0062 which has an input impedance less than 500Kohm.**

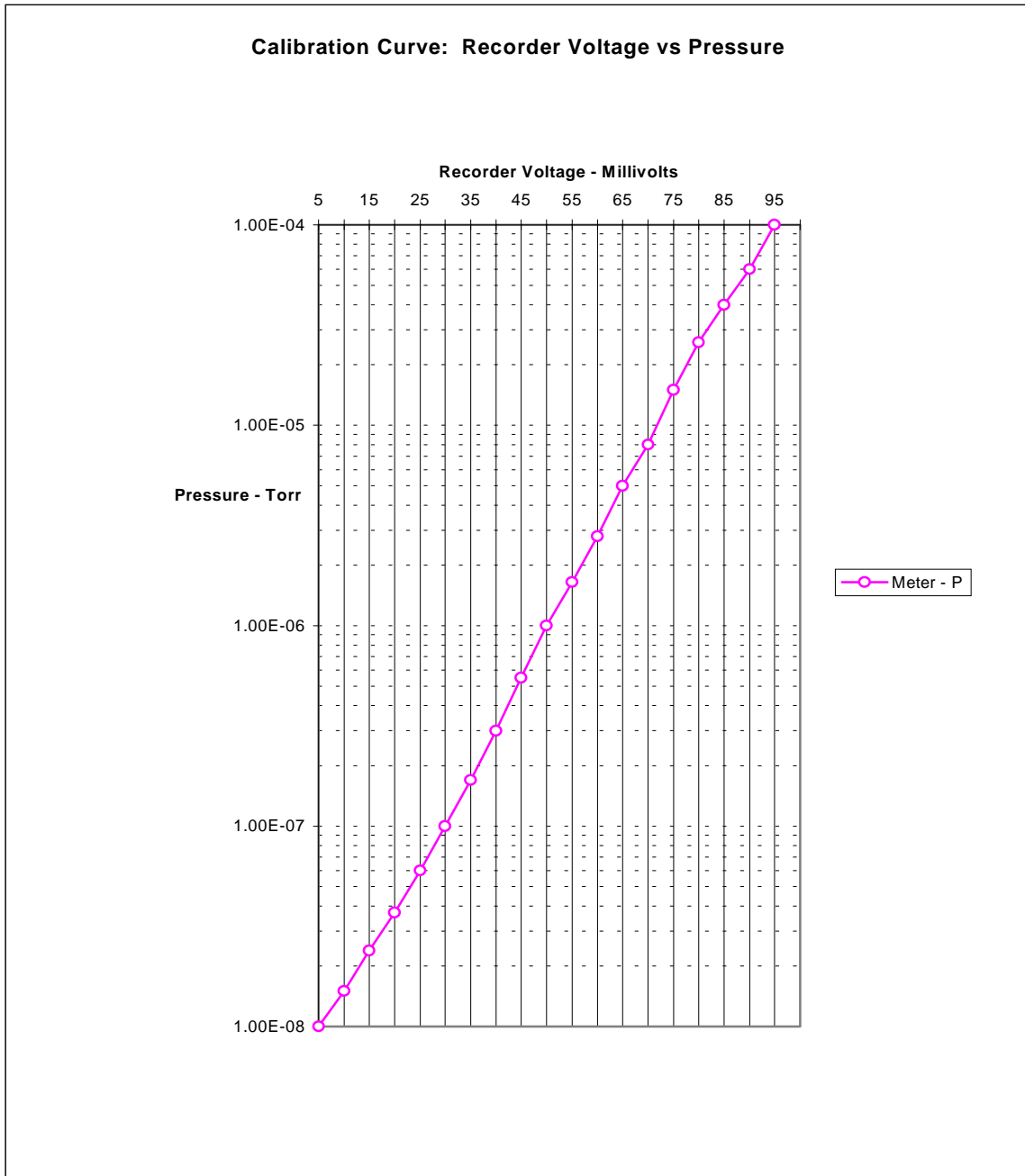

**Figure 6 Recorder Output versus Pressure Plot Chart**

## IV Operation

Operation of the IPC-0062 is described for two modes: the START mode and the NORMAL operating mode.

### A. Pre-Start Checks

Prior to any operation, perform the following checks: (See Figure 4 and Figure 7)

1. Verify that all grounding is in place and secure.
2. Verify that (or set) the pump selector switch (S6) on the rear panel to the correct position for the sputter ion pump in use.
3. Verify that (or set) the voltage polarity switch (S3) on the rear panel to the correct polarity. Positive (+) polarity is used for diode, noble diode and DI pumps while negative (-) polarity is used for triode and StarCell pumps.
4. Verify (or set) the START-PROTECT switch (S7) on the front panel to START.
5. Set the METER RANGE SELECTOR SWITCH (S5) on the front panel to the 6KV position.

Now, rough pump the system to a pressure of 10 mTorr (10 microns) or below. Cryosorption roughing is strongly recommended, however a two stage oil sealed rotary pump or other roughing pump can be used with careful attention to technique and appropriate trapping of pump oils.

#### **CAUTION**

**At pressures below about 150 mTorr for most systems and pumps, the backstreaming of mechanical pump oil is a significant problem. High quality oil traps MUST be used.**



**Figure 7 Front Panel Photograph**

**B. Start-Mode Operation**

1. Turn the POWER switch (S1) on the front panel to ON. The red High Voltage ON lamps on the front and rear panels will light. No warm-up period is required.
2. **IMMEDIATELY** check the voltage indication on the front panel meter for the following indications:

Diode Pump	300 Volts (approximately)
Triode Pump	1,100 Volts (approximately)

If the voltage reading is zero, there is a short circuit or possibly an arc-mode discharge in the pump. If this occurs, *IMMEDIATELY* turn the POWER switch to the OFF position. Find and correct the fault.

3. Turn the METER RANGE selector switch on the front panel to the 200 mA position and verify that the current is near the appropriate value for the voltage observed in the previous step.

For a diode pump starting at 300 volts, the current should be approximately in the 100-150 mA range.

For a triode pump starting at 1100 volts, the current should be approximately in the 100-150 mA range.

See Figure 1 and Figure 2 for current versus voltage charts (bar graph portion) for the two different high voltage configurations of the IPC-0062.

4. Return the METER RANGE selector switch to the 6 kV position to monitor the “start” of the pump.

*NOTE*

The voltage is a more reliable indication that the ion pump is about to “start” than is the current.

5. When it is suspected or observed that the roughing system has reached its base pressure, close the roughing valve.

If the voltage falls (meaning that current and therefore pressure is rising), reopen the roughing valve.

If the voltage increases or remains constant (pressure is decreasing or “holding”), leave the roughing valve closed.

*NOTE*

With a diode sputter ion pump, a modest rise in pressure is normal during the initial START. This is caused by heating of the pump components and is beneficial in outgassing the elements for later operation in the NORMAL mode.

6. When the voltage has increased to about 2 kV, place the START-PROTECT switch in the PROTECT position. The white START lamp above the switch will go out.

The system is now protected against a rise in pressure above about 0.5 mTorr while it is unattended. Should such a pressure rise occur due to a leak or other failure, the control unit will turn off automatically after a delay of a few seconds. This will avoid any damage to the control unit or pump due to prolonged operation in high power.

### C. Normal-Mode Operation

Operation in the NORMAL mode is simple and automatic. As the pressure and current fall, the operating voltage approaches the open circuit value for the control unit; and the current is approximately proportional to pressure over a wide range of pressures. See Figure 8 for some examples of pump current vs. Pressure.

Pressure at the pump inlet flange may be read directly on the “pressure” scale of the front panel meter by selecting PRESSURE on the METER SCALE selector switch. (This assumes that the pump selector switch on the rear panel is set properly.) The calibration of this range is adjusted by the CALIBRATE potentiometer on the rear panel. This calibration has been set at the factory for best accuracy and should generally not be adjusted by the user.

Alternately, if the current vs. Pressure relationship is known for the pump in use, current may be read directly and converted into a pressure reading. Data for the Varian pumps suitable for use with the IPC-0062 is provided in Figure 8.

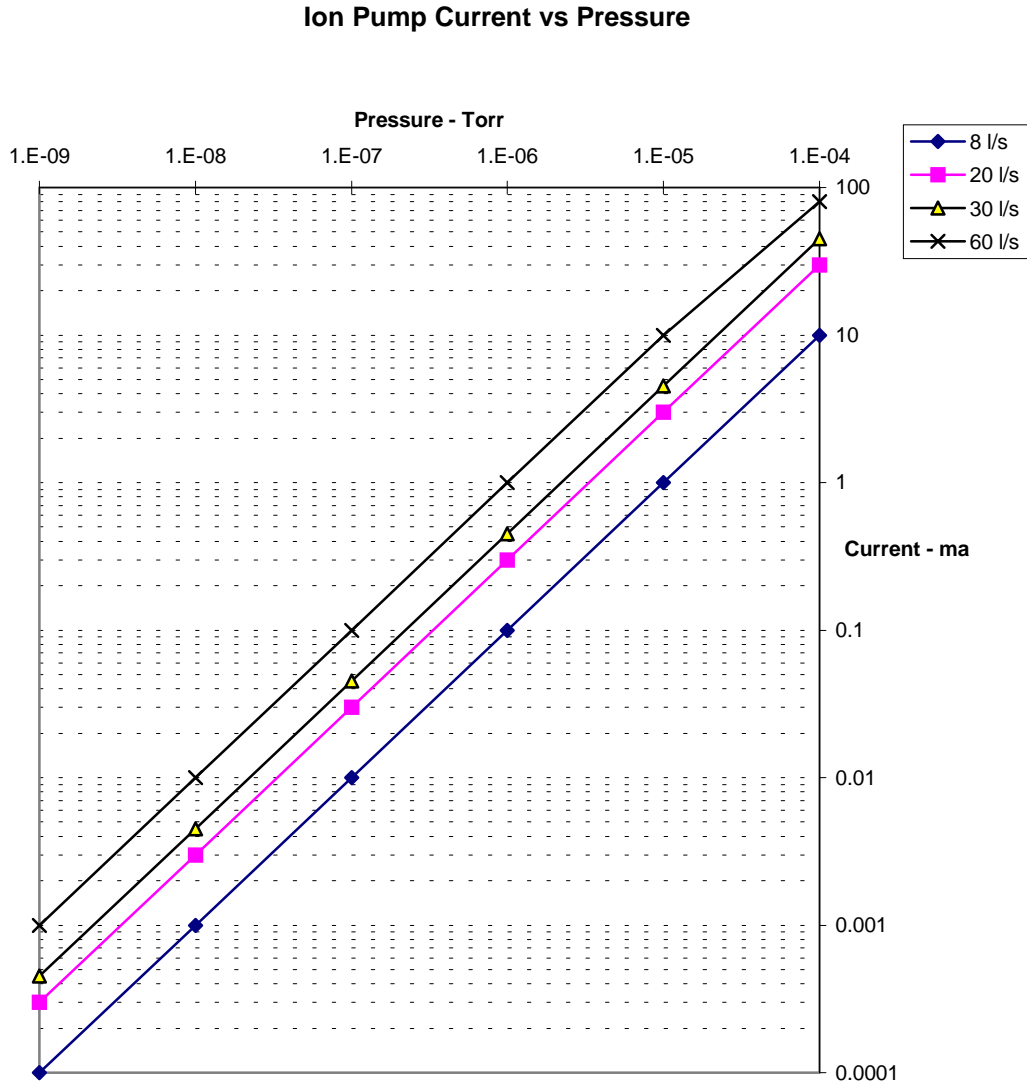

**Figure 8 Pump Current vs. Pressure, Selected Ion Pumps**



## DISCUSSION OF THE TECHNIQUE

While it is true that the current drawn in a sputter-ion pump is nearly proportional to pressure over a wide range, there are limitations to the technique. Specifically:

1. The proportionality is only approximate.
2. At pressures less than  $1 \times 10^{-8}$  Torr, the current to the Penning discharge is multiple valued, displaying significant hysteresis. Thus the current drawn depends on whether the pressure is rising or falling.
3. Sharp points and edges, or flakes which may form with prolonged pump use, particularly in triode pumps, can add significant current, due to field emission, which is independent of the pressure. (These field emission points can be removed by “hi-potting” the pump, that is, by applying AC or DC voltages to the pump of at least twice the operating voltage.)

For these reasons, the accuracy of the pressure as indicated by the ion pump current is no better than +/-20%, and that accuracy is only achieved in the pressure range between  $1 \times 10^{-7}$  Torr and  $1 \times 10^{-5}$  Torr.

For pressures below  $1 \times 10^{-7}$  Torr, a Bayard-Alpert ionization gauge is strongly recommended. The pressure indication on the IPC-0062 is semi-quantitative.

For pressures below  $1 \times 10^{-8}$  Torr, a Bayard-Alpert ionization gauge is required. Any pressure indication on the IPC-0062 of less than  $10^{-8}$  Torr would be of dubious validity, and so the meter scale does not provide numerical indications below that value. Note that for large sputter ion pumps, it is possible to extrapolate the current value to extremely low pressures and obtain a “reading” for the pressure. This is subject to the same fundamental limitations indicated above, and is therefore not meaningful.

Note that these effects, while significant to the measurement of pressure, have only minor effects on the pumping efficiency, and for that purpose may be generally neglected.

V Parts List & Schematic

A. List

<u>REFERENCE DESIGNATOR</u>	<u>DESCRIPTION</u>
C1	Capacitor, 2 x 0.3 uF, 5kV (dual)
C2,C3,C7	Capacitor, 47 uF, 50 V, axial, non polarized
C4	Capacitor, 220 uF, 25 V, axial
C5	Capacitor, 22 uF, 50 V, axial, non polarized
C6	Capacitor, 1,000 uF, 25 V, coaxial
D1	Diode, high voltage rectifier stack
D2, D3	Diode, silicon, DO-4
D4	Diode, silicon, DO-4, reversed
D5	Diode, silicon, DO-4
D6	Diode, bridge rectifier, 1 A
D7, D8	Diode Silicon, 1 A, 600 V
DS1	Lamp, front panel, red neon, 125V, 0.5W
DS2	Lamp, rear panel, red neon, 125V, 0.5W
DS3	Lamp, start, amber incandescent, 12VDC, 1W
DS4, DS5	Lamp, front panel, white incandescent, 12V, 1W
DS6	Lamp, over current trip, neon glow
F1	Fuse, ceramic 10 A (115 VAC), 5A (230VAC)
F2	Fuse, sloblo submini, 2AG, 0.5A, 230V
J1	Power receptacle, male recessed, 15A, 250V
J2	Connector, pressure relay
J3G	Green banana jack, pressure recorder, 100 mV
J3Y	Yellow banana jack, pressure recorder, 100mV
J4	Connector, high voltage output
J5	Safety ground insulated binding post
K1	Relay, 12 V/SPST, over current trip ass'y
K2	Relay, 12 V/4PDT, pcb ass'y
K3	Relay, 12V/DPDT, pcb ass'y
K4	Relay, DIP/4PDT, pcb ass'y
M1	Meter, 20 uA taut band, special
R1	Resistor, 100 ohm, 50W, +5%
R2	Resistor, 10 Mohm, 5W, +5%, high voltage
R3	Resistor, 200 ohm, 50W, +5%
R4	Resistor, 100 Mohm, 5W, +5%, high voltage
R5	Resistor, 2.55 Kohm, 1W, +1%, metal film
R6	Potentiometer, 500 ohm, 2W, linear resistance
R7	Resistor, 4990 ohm, 1/2W, +1%, metal film

<u>REFERENCE DESIGNATOR</u>	<u>DESCRIPTION</u>
R8	Resistor, 124 ohm, 1/2W, +1%, metal film
R9	Resistor, 27 Kohm, 1/2W, +1%, metal film
R10	Resistor, 21 Kohm, 1/2W, +1%, metal film
R11	Resistor, 18 Kohm, 1/2W, +1%, metal film
R12	Resistor, 15 Kohm, 1/2W, +1%, metal film
R13	Resistor, 8.2 Kohm, 1/2W, +1%, metal film
R14	Resistor, 12 Kohm, 1/2W, +1%, metal film
R15	Resistor, 18 Kohm, 1/2W, +1%, metal film
R16	Potentiometer, 10 Kohm, 1/2W
R17	Resistor, 100 Kohm, 1/2W, +1%, metal film
R18	Resistor, 27 Kohm, 1/2W, +1%, metal film
R19	Resistor, 12 Kohm, 1/2W, +1%, metal film
R20	Resistor, 6.8 Kohm, 1/2W, +1%, metal film
R21	Resistor, 15 Kohm, 1/2W, +1%, metal film
R22	Resistor, 604 ohm, 1/2W, +1%, metal film
R23	Resistor, 60.4 ohm, 1/2W, +1%, metal film
R24	Resistor, 6.04 ohm, 1/4W, +1%, metal film
R25	Resistor, 0.665 ohm
R26	Resistor, 3 Kohm, 1W, +5%, metal oxide
R27	Resistor, 30 ohm, 1/2W, +5%, metal film
R28	Resistor, 30 ohm, 1/2W, +1%, metal film
R29	Resistor, 51 ohm, 1/2W, +1%, metal film
R30	Resistor, 30 ohm, 1/2W, +1%, metal film
R31	Resistor, 2.75 ohm, 1W, +1%, metal film
R32	Resistor, 100 ohm, 1W, +1%, metal oxide
RA	Resistor, 75 ohm, 5W, wirewound
RB	Resistor, 20 Kohm, 1/4W
RX	Resistor, 30 ohm, 1/2W, +1%, metal film
RZ	Resistor, 15 Kohm, 1/4W, +1%, metal film
S1	Switch. Toggle, on/off, DPST
S2	Switch, PC Board, 115/230V crossover
S3	Switch, high voltage polarity, 2 POS, 5200V
S4	Switch, pushbutton, reset
S5	Switch, 3 P-11 POS, shorting (custom mfg)
S6	Switch, 4 P-11 POS, shorting (custom mfg)
S7	Switch, toggle, start/protect, 2PST
T1	Transformer, high voltage
T2	Transformer, dual voltage
TB1	Contact/Header/Cable (3 pin, 0.156 s.)
TB2	Contact/Header/Cable (6 pin, 0.156 ctr.)
TB3	Contact/Header/Cable (5 pin, 0.156 ctr.)
VR1	Metal oxide varistor

B. Schematic

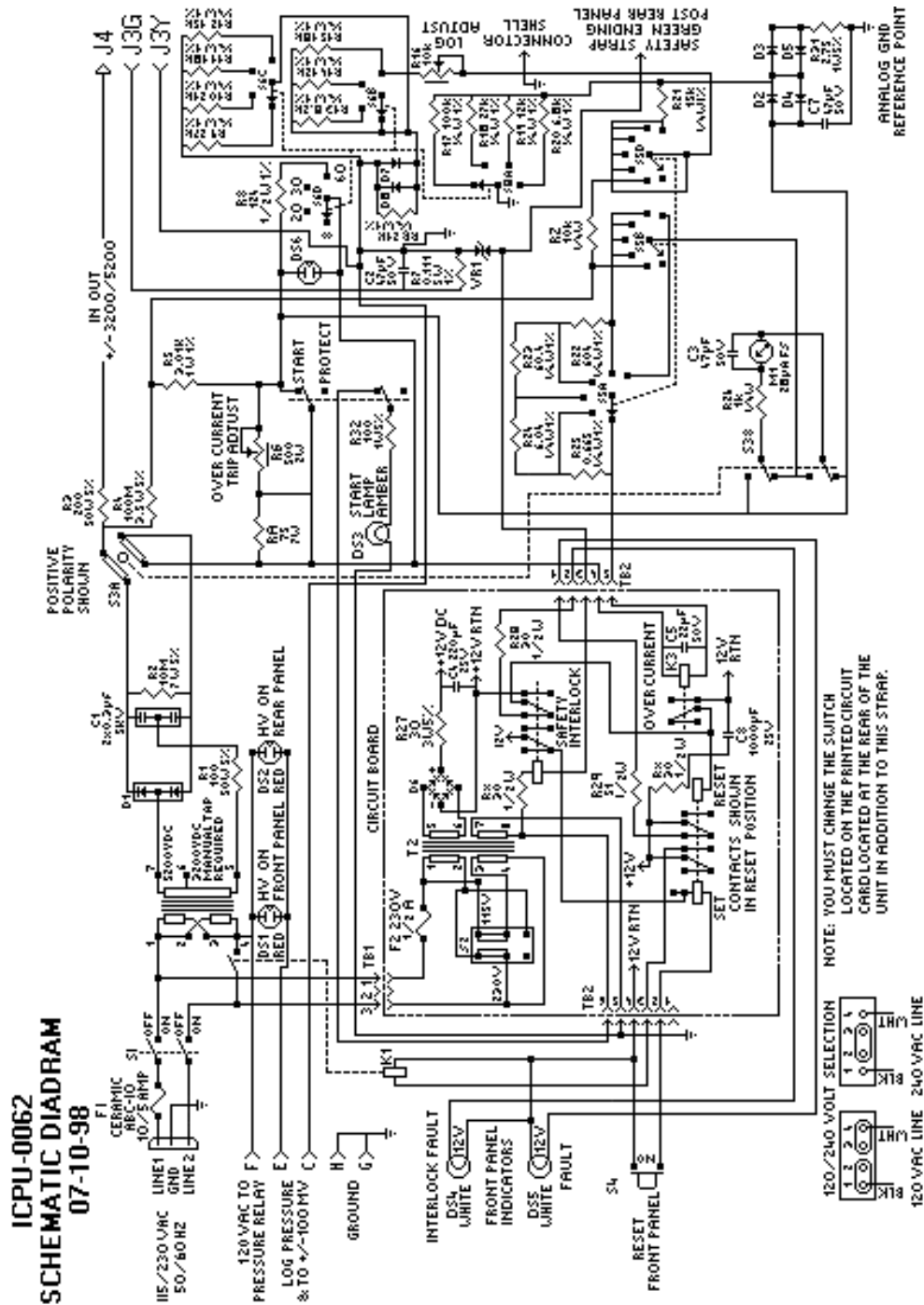

rev 062899sr